

NEEDLE ROLLER BEARING WITH MACHINED RINGS

METRIC WITH FLANGES, WITHOUT INNER RING

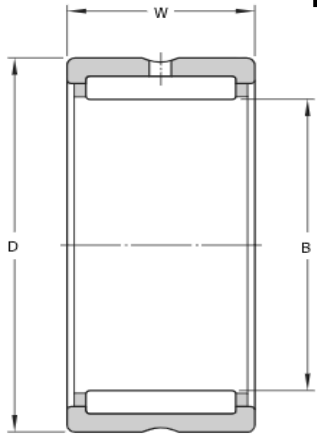

Part Number	Bore (B) mm	Outer (D) mm	Width (W) mm	Load Ratings (N)		Limiting Speed RPM	Weight kg
				Dynamic C	Static C ^{or}		
NK5/10	5	10	10	2100	1400	36780	0.0031
NK5/12	5	10	12	3060	2385	36780	0.0037
NK6/10	6	12	10	2655	2052	34000	0.0047
NK7/10	7	14	10	3060	2385	34000	0.0069
NK7/12	7	14	12	3690	3150	34000	0.0082
NK8/12	8	15	12	3950	4100	32000	0.0087
NK8/16	8	15	16	5220	5220	32000	0.012
NK8/16	8	15	16	5220	5220	32000	0.012
NK9/12	9	16	12	4590	4500	18000	0.0103
NK9/16	9	16	16	5940	6390	18000	0.0128
NK10/12	10	17	12	4750	5300	29000	0.0101
NK10/16	10	17	16	6200	7800	29000	0.0133

NEEDLE ROLLER BEARING WITH MACHINED RINGS

METRIC WITH FLANGES, WITHOUT INNER RING

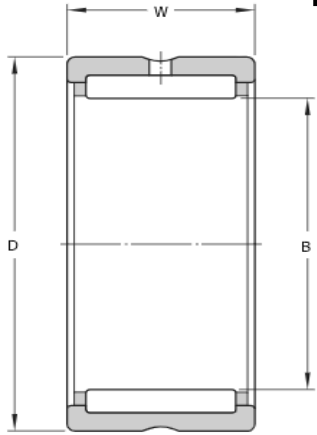

Part Number	Bore (B) mm	Outer (D) mm	Width (W) mm	Load Ratings (N)		Limiting Speed RPM	Weight kg
				Dynamic C	Static C ^{or}		
NKS10	10	19	13	5800	6000	29000	0.016
RNA4900-2RS	10	22	14	6930	6210	25000	0.0165
NK12/12	12	19	12	6000	6400	27000	0.0121
NK12/16	12	19	16	8200	9800	27000	0.0159
NKS12	12	22	16	8800	9200	26000	0.025
NK14/12	14	22	12	7600	9200	25000	0.0156
RNA4900	14	22	13	8500	9000	25000	0.0165
NK14/16	14	22	16	10100	11500	25000	0.0207
NK14/20	14	22	20	12800	15600	25000	0.0255
NKS14	14	25	16	1400	13800	24000	0.027
NK15/16	15	23	16	10700	12700	24000	0.0218
NK15/20	15	23	20	13600	17200	24000	0.0266

NEEDLE ROLLER BEARING WITH MACHINED RINGS

METRIC WITH FLANGES, WITHOUT INNER RING

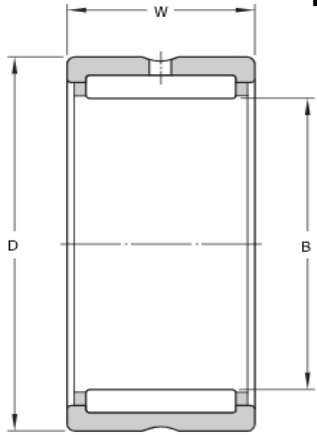

Part Number	Bore (B) mm	Outer (D) mm	Width (W) mm	Load Ratings (N)		Limiting Speed RPM	Weight kg
				Dynamic C	Static C ^{or}		
NKS15	15	26	16	10000	11000	23000	0.03
RNA4901	16	24	13	6400	8900	15500	0.0174
NK16/16	16	24	16	11300	13900	23000	0.0224
NK16/20	16	24	20	14670	16800	23000	0.0284
RNA6901	16	24	22	14000	18600	15500	0.031
NKS16	16	28	16	14900	15000	20000	0.03
NK17/16	17	25	16	12150	13500	14000	0.0237
NK17/20	17	25	20	15000	20000	23000	0.0298
NK18/16	18	26	16	12500	16200	22000	0.0249
NK18/20	18	26	20	15500	19800	22000	0.0314
NKS18	18	30	16	11000	12200	21000	0.038
NK19/16	19	27	16	13000	17000	22000	0.0261

NEEDLE ROLLER BEARING WITH MACHINED RINGS

METRIC WITH FLANGES, WITHOUT INNER RING

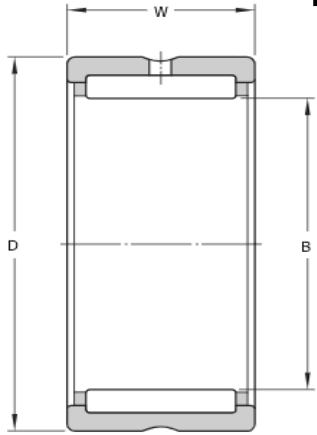

Part Number	Bore (B) mm	Outer (D) mm	Width (W) mm	Load Ratings (N)		Limiting Speed RPM	Weight kg
				Dynamic C	Static C ^{or}		
NK19/20	19	27	20	16830	21240	22000	0.0322
RNA4902	20	28	13	11000	12900	12000	0.0217
NK20/16	20	28	16	13140	15750	21000	0.027
NK20/20	20	28	20	16740	21420	21000	0.0339
RNA6902	20	28	23	10800	12800	12000	0.0397
NKS20	20	32	20	23400	22500	20000	0.0487
NK21/16	21	29	16	13500	18700	21000	0.0281
RNA4903-2RS	22	30	13	9000	9900	12000	0.0224
RNA4903	22	30	13	12000	16800	16300	0.0222
NK22/16	22	30	16	13500	18000	11500	0.03
NK22/20	22	30	20	18000	24300	11500	0.037
RNA6903	22	30	23	14000	19900	16300	0.0424

NEEDLE ROLLER BEARING WITH MACHINED RINGS

METRIC WITH FLANGES, WITHOUT INNER RING

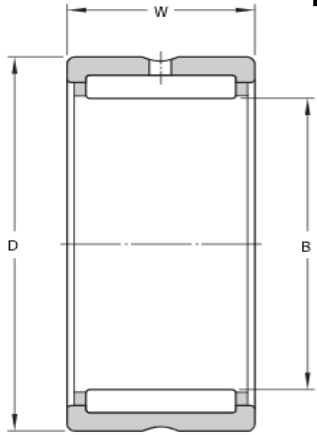

Part Number	Bore (B) mm	Outer (D) mm	Width (W) mm	Load Ratings (N)		Limiting Speed RPM	Weight kg
				Dynamic C	Static C ^{or}		
NKS22	22	35	20	24750	25200	17000	0.0615
NK24/16	24	32	16	15210	20070	10000	0.0319
NK24/20	24	32	20	19260	27450	10000	0.04
NKS24	24	37	20	26550	27900	16900	0.0655
NK25/16	25	33	16	15120	20160	15000	0.0326
NK25/20	25	33	20	16800	28500	15000	0.042
NK25/30	25	33	30	18800	30500	165000	0.0556
RNA4904	25	37	17	21330	22950	15000	0.0523
RNA6904	25	37	30	26000	43000	15000	0.1
NKS25	25	38	20	25800	31000	16300	0.0681
NK26/16	26	34	16	15000	23000	16300	0.034
NK26/20	26	34	20	19800	28880	16300	0.042

NEEDLE ROLLER BEARING WITH MACHINED RINGS

METRIC WITH FLANGES, WITHOUT INNER RING

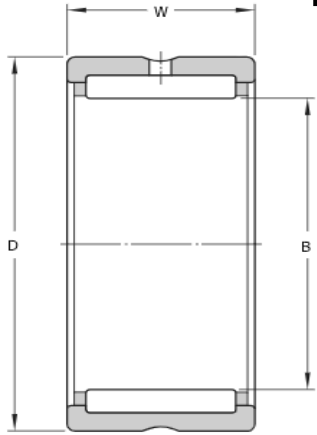

Part Number	Bore (B) mm	Outer (D) mm	Width (W) mm	Load Ratings (N)		Limiting Speed RPM	Weight kg
				Dynamic C	Static C ^{or}		
NK28/20	28	37	20	22000	34000	16500	0.0522
NK28/30	28	37	30	33000	57000	12000	0.082
RNA49/22	28	39	17	23400	26550	15000	0.0502
RNA69/22	28	39	30	37800	49500	9000	0.098
NKS28	28	42	20	25900	33500	15000	0.0836
NK49/28	28	45	17	34600	62200	6700	0.0977
NK29/20	29	38	20	21900	34000	15000	0.0537
NK29/30	29	38	30	32500	57000	15000	0.0843
NK30/20	30	40	20	25200	36900	15000	0.065
NK30/30	30	40	30	37800	62100	15000	0.0979
RNA4905	30	42	17	23600	31500	14000	0.061
RNA6905	30	42	30	39000	59000	14000	0.112

NEEDLE ROLLER BEARING WITH MACHINED RINGS

METRIC WITH FLANGES, WITHOUT INNER RING

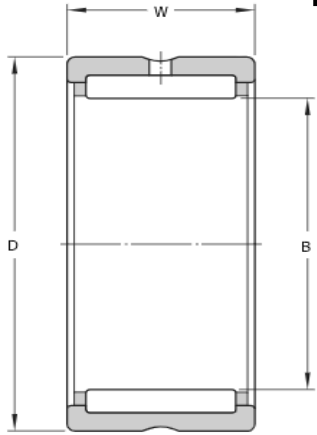

Part Number	Bore (B) mm	Outer (D) mm	Width (W) mm	Load Ratings (N)		Limiting Speed RPM	Weight kg
				Dynamic C	Static C ^{or}		
NKS30	30	45	22	32000	40000	14000	0.104
NK32/20	32	42	20	26550	40050	15000	0.068
NK32/30	32	42	30	33500	60000	12000	0.102
NKS32	32	47	22	31000	40000	12000	0.11
NK35/20	35	45	20	27900	43650	12000	0.0738
NK35/30	35	45	30	41400	71900	12000	0.112
RNA4906	35	47	17	17000	30500	12000	0.0694
RNA6906	35	47	30	35000	67000	12000	0.126
NKS35	35	50	22	35550	42300	11900	0.118
NK37/20	37	47	20	24900	43500	12000	0.077
NK37/30	37	47	30	37800	65700	12000	0.113
NKS37	37	52	22	37350	45000	11000	0.123

NEEDLE ROLLER BEARING WITH MACHINED RINGS

METRIC WITH FLANGES, WITHOUT INNER RING

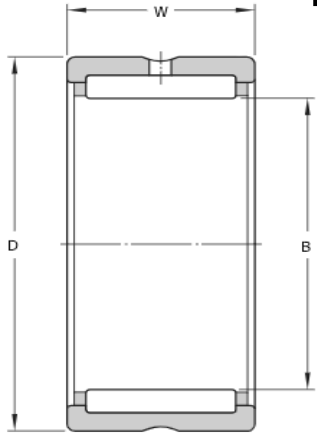

Part Number	Bore (B) mm	Outer (D) mm	Width (W) mm	Load Ratings (N)		Limiting Speed RPM	Weight kg
				Dynamic C	Static C ^{or}		
NK38/20	38	48	20	25500	45000	12000	0.0794
NK38/30	38	48	30	38000	76000	12000	0.114
NK40/20	40	50	20	26500	43000	11000	0.0827
NK40/30	40	50	30	37500	79000	11000	0.125
RNA69/32	40	52	36	42500	79000	8500	0.162
NKS40	40	55	22	38000	54000	10900	0.129
NK42/20	42	52	20	23900	45000	10000	0.0827
NK42/30	42	52	30	40050	73800	10000	0.13
RNA4907	42	55	20	19800	41500	8700	0.107
RNA6907	42	55	36	26000	60500	8700	0.193
NK43/20	43	53	20	25700	75000	10000	0.086
NK43/30	43	53	30	39000	75000	10000	0.133

NEEDLE ROLLER BEARING WITH MACHINED RINGS

METRIC WITH FLANGES, WITHOUT INNER RING

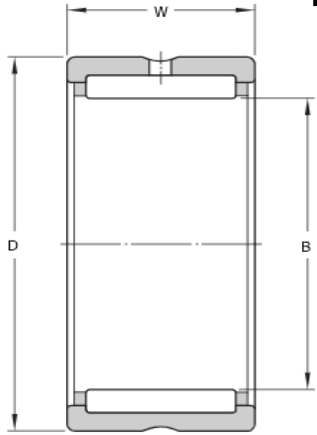

Part Number	Bore (B) mm	Outer (D) mm	Width (W) mm	Load Ratings (N)		Limiting Speed RPM	Weight kg
				Dynamic C	Static C ^{or}		
NKS43	43	58	22	39600	51300	9500	0.139
NK45/20	45	55	20	31500	55800	7650	0.915
NK45/30	45	55	30	41000	88000	7650	0.139
NKS45	45	60	22	40500	60000	9000	0.145
NK47/30	47	57	30	43000	94000	7650	0.18
RNA4908	48	62	22	31000	63000	8120	0.14
RNA6908	48	62	40	64000	112000	8120	0.256
NK50/25	50	62	25	43650	78300	7800	0.158
NK50/35	50	62	35	60300	118800	7800	0.221
NKS50	50	65	22	43200	60300	8500	0.157
RNA4909	52	68	22	37000	69500	7600	0.182
RNA6909	52	68	40	61500	123500	7600	0.338

NEEDLE ROLLER BEARING WITH MACHINED RINGS

METRIC WITH FLANGES, WITHOUT INNER RING

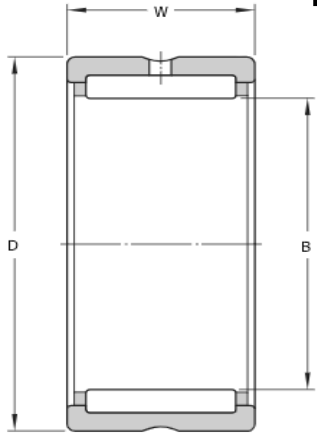

Part Number	Bore (B) mm	Outer (D) mm	Width (W) mm	Load Ratings (N)		Limiting Speed RPM	Weight kg
				Dynamic C	Static C ^{or}		
NK55/25	55	68	25	40950	73800	7600	0.18
NK55/35	55	68	35	55000	106200	7600	0.25
NKS55	55	72	22	45000	74000	7600	0.221
RNA4910	58	72	22	41000	72000	7500	0.163
RNA6910	58	72	40	68000	135000	7500	0.31
NK60/25	60	72	25	47700	92700	7000	0.185
NK60/35	60	72	35	56000	117000	7000	0.258
NKS60	60	80	28	63000	98000	7000	0.335
RNA4911	63	80	25	50600	96580	7000	0.255
RNA6911	63	80	45	82560	172000	7000	0.47
NK65/35	65	78	35	59000	142000	7000	0.31
NKS65	65	85	28	67000	108000	7000	0.356

NEEDLE ROLLER BEARING WITH MACHINED RINGS

METRIC WITH FLANGES, WITHOUT INNER RING

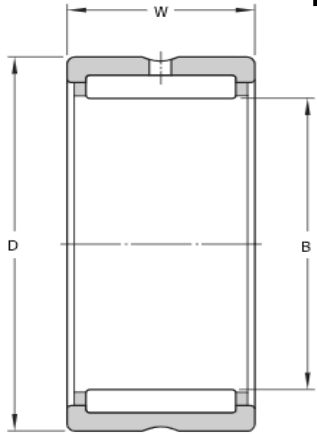

Part Number	Bore (B) mm	Outer (D) mm	Width (W) mm	Load Ratings (N)		Limiting Speed RPM	Weight kg
				Dynamic C	Static C ^{or}		
NK68/25	68	82	25	43500	89000	7000	0.241
NK68/35	68	82	35	63000	125100	6000	0.338
RNA4912	68	85	25	52800	91050	7000	0.275
RNA6912	68	85	45	88500	186000	7000	0.488
NK70/25	70	85	25	44500	92000	6500	0.26
NK70/35	70	85	35	63000	144000	6500	0.37
NKS70	70	90	28	69300	101700	6000	0.38
RNA4913	72	90	25	57500	110500	6500	0.312
RNA6913	72	90	45	87600	194500	6500	0.58
NK73/25	73	90	25	54000	90000	5600	0.302
NK73/35	73	90	35	76500	140400	5600	0.428
NK75/25	75	92	25	54000	104000	6000	0.315

NEEDLE ROLLER BEARING WITH MACHINED RINGS

METRIC WITH FLANGES, WITHOUT INNER RING

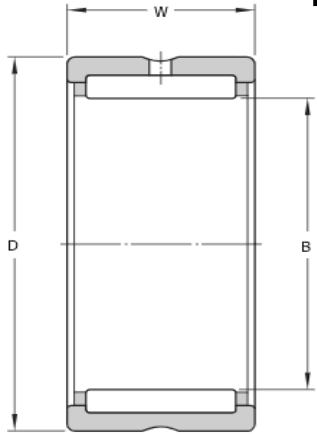

Part Number	Bore (B) mm	Outer (D) mm	Width (W) mm	Load Ratings (N)		Limiting Speed RPM	Weight kg
				Dynamic C	Static C ^{or}		
NK75/35	75	92	35	77000	162000	6000	0.445
NKS75	75	95	28	67000	125400	5200	0.402
NKS80	80	100	28	72000	127000	5600	0.44
RNA4914	80	100	30	79000	154000	5500	0.46
RNA6914	80	100	54	121000	263000	5500	0.857
NK80/25	80	95	25	62000	123000	4900	0.301
NK80/35	80	95	35	85000	185000	4900	0.425
NK85/25	85	105	25	69000	123000	5500	0.425
NKS85	85	105	28	63000	151000	4600	0.6
RNA4915	85	105	30	82000	158000	5500	0.489
NK85/35	85	105	35	98000	193000	5500	0.6
RNA6915	85	105	54	128000	272000	5500	0.935

NEEDLE ROLLER BEARING WITH MACHINED RINGS

METRIC WITH FLANGES, WITHOUT INNER RING

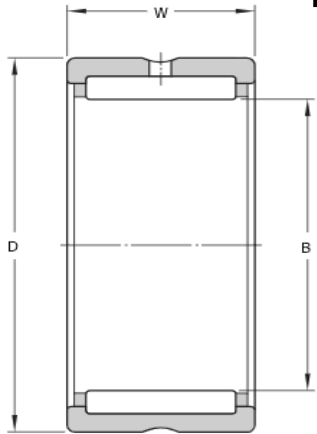

Part Number	Bore (B) mm	Outer (D) mm	Width (W) mm	Load Ratings (N)		Limiting Speed RPM	Weight kg
				Dynamic C	Static C ^{or}		
NK90/25	90	110	25	81000	136000	4400	0.45
RNA4916	90	110	30	81000	170500	5000	0.516
NK90/35	90	110	35	103000	20800	5000	0.63
RNA6916	90	110	54	130500	280600	5000	0.987
NK95/26	95	115	26	73000	137000	4800	0.49
NK100/26	100	120	26	76500	146000	4600	0.515
RNA4917	100	120	35	98000	207000	4600	0.657
NK100/36	100	120	36	111000	237000	4600	0.715
RNA6917	100	120	63	161000	337000	4600	1.2
NK105/26	105	125	26	78000	155000	4000	0.54
RNA4918	105	125	35	98500	239000	4000	0.745
NK105/36	105	125	36	114000	250000	4000	0.713

NEEDLE ROLLER BEARING WITH MACHINED RINGS

METRIC WITH FLANGES, WITHOUT INNER RING

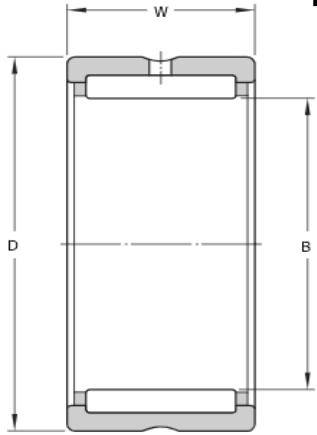

Part Number	Bore (B) mm	Outer (D) mm	Width (W) mm	Load Ratings (N)		Limiting Speed RPM	Weight kg
				Dynamic C	Static C ^{or}		
RNA6918	105	125	63	174000	38000	4000	1.33
NK110/30	110	130	30	98000	21000	4200	0.65
RNA4919	110	130	35	112000	245000	3870	0.719
NK110/40	110	130	40	127000	29000	4200	0.83
RNA6919	110	130	63	196000	400000	3870	1.46
RNA4920	115	140	40	120000	264000	3700	1.15
RNA4922	125	150	40	124000	270000	3300	1.24
RNA4824	130	150	30	112000	248000	3200	0.75
RNA4924	135	165	45	174000	386000	2900	1.86
RNA4926	150	180	50	216000	44000	2600	2.21
RNA4928	160	190	50	228000	460000	2900	2.35